

Linear

TANA Asymmetric AS30 (30W) Fixture Guide

KKDÖ

Indoor | Surface | Output up to 2970lm/m (905lm/ft)



Key applications

- ✓ Architectural detail
- ✓ Cabinet & furniture
- ✓ Direct lighting
- ✓ Display case
- ✓ Interior
- ✓ Retail display
- ✓ Shelving display
- ✓ Wall grazing

Key features

- ✓ A-line (High Efficacy)
- ✓ Asymmetric lens
- ✓ Custom lengths
- ✓ Constant Voltage (CV)
- ✓ Continuous light runs
- ✓ Diffusion: homogenous
- ✓ Direct view
- ✓ High lumen efficacy
- ✓ IP40 dry area
- ✓ Lens options

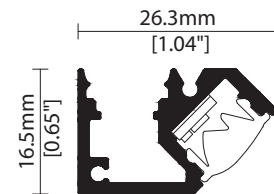

FIXING METHODS



KKCP-10 Concealed clip

Linear

TANA Asymmetric AS30 (30W)

Specification sheet



Dimensions	H16.5/W26.3/L90-1013mm (H0.65/W1.04/L3.54-39.88in)
PCB Cut-point	38.46mm increment/1000mm max (1.51in increment/39.37in max)
LED Pitch	4.8mm - 208LED/m (0.19in - 64LED/ft)
Chip	A-line
Cover/Optics	KKLN-A2 Asymmetric lens (Beam tilt 30°, Beam angle 45°)
CCT	A-line: 2700K/3000K/3500K/4000K
LED binning	A-line: 3-step MacAdam ellipse
CRI	94
Lifetime	50,000 hours @ 25°C (50,000 hours @ 77°F)
Operating temp	T _a = -25 to 45°C (T _c max = 75.1°C) T _a = -13 to 113°F (T _c max = 167°F)
IP Rating	IP40
Finish	Silver anodised
Mounting	Surface mounting via concealed clips
Power feed	Hardwire tails or male/female connectors
Control	0-10V/1-10V/DMX/DALI



LED Grading Key

Exclusive Grade *KKDC tuned CCT range
A-line* 3-step CCT range
 KKDC highest lumen efficacy LED

Power consumption	Supply voltage	Supply current
30W/m (9.14W/ft)	24V DC	1.25A/m (0.381A/ft)

Performance Data (3000K)

A-line	R1	R2	R3	R4	R5	R6	R7	R8	R9	R10	R11	R12	R13	R14
	94	96	96	94	93	94	95	88	71	89	89	94	77	95

	KKLN-A2	CRI	R9	Rf	Rg
A-line	2970lm/m (905lm/ft) 99lm/w	94	71	-	-

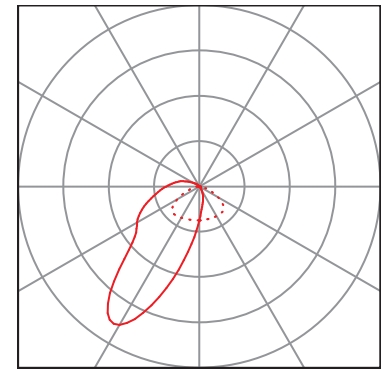
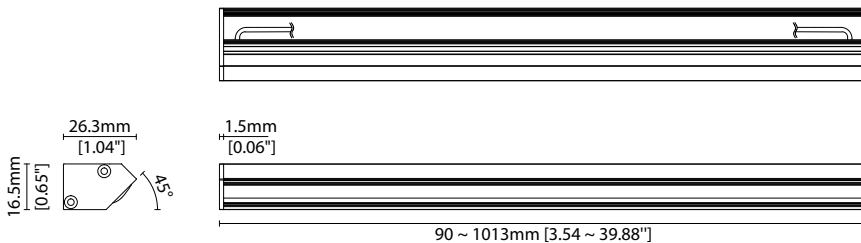

KKLN-A2 Asymmetric Lens
 — C0 / C180 cd / 1000 lm C90 / C270

Data derived from independent UKAS / IESNA LM-79-08 accredited testing of production samples.

Linear

TANA Asymmetric AS30 (30W) Photometric Simulation



TANA Asymmetric AS30

Efficiency: 99lm/w

Light output: 2970 lm/m

TANA Asymmetric increases light efficiency by 57% and light output by 70%. In addition, shelf lighting should brightly illuminate the entire interior and the bottom surface, and can evenly irradiate bright light to the center of the lower surface without a spotlight.

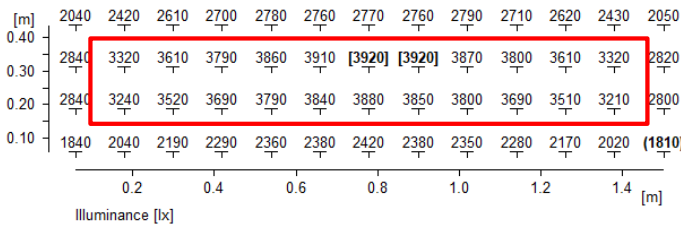
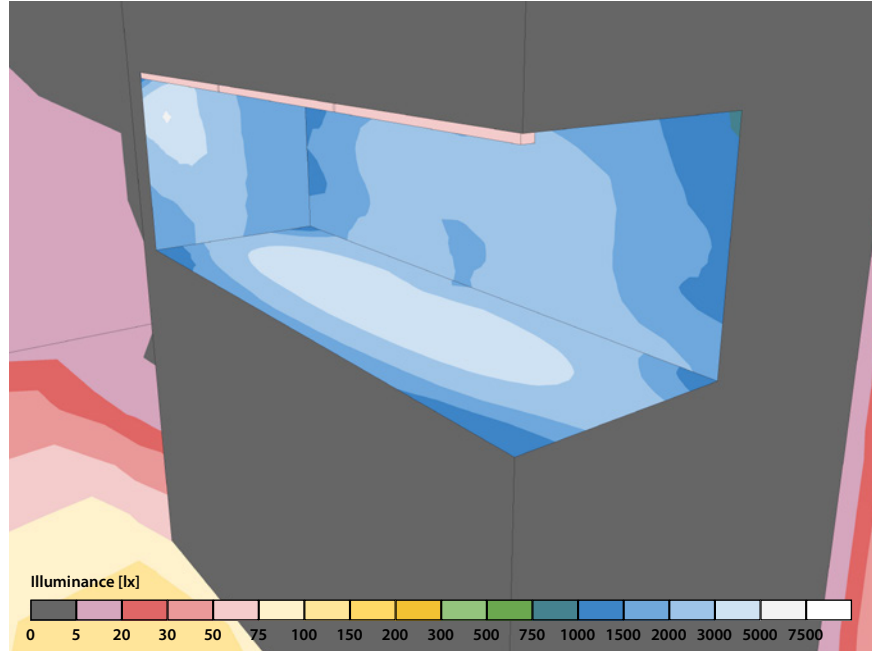

Height reference plane
Average illuminance
Minimum illuminance
Maximum illuminance
Uniformity Uo
Diversity Ud

Em : 1.00 m
Average illuminance : 2970 lx
Emin : 1810 lx
Emax : 3920 lx
Emin/Em : 1 : 1.64 (0.61)
Emin/Emax : 1 : 2.17 (0.46)

Comparison example:

TANA R014 (x2)

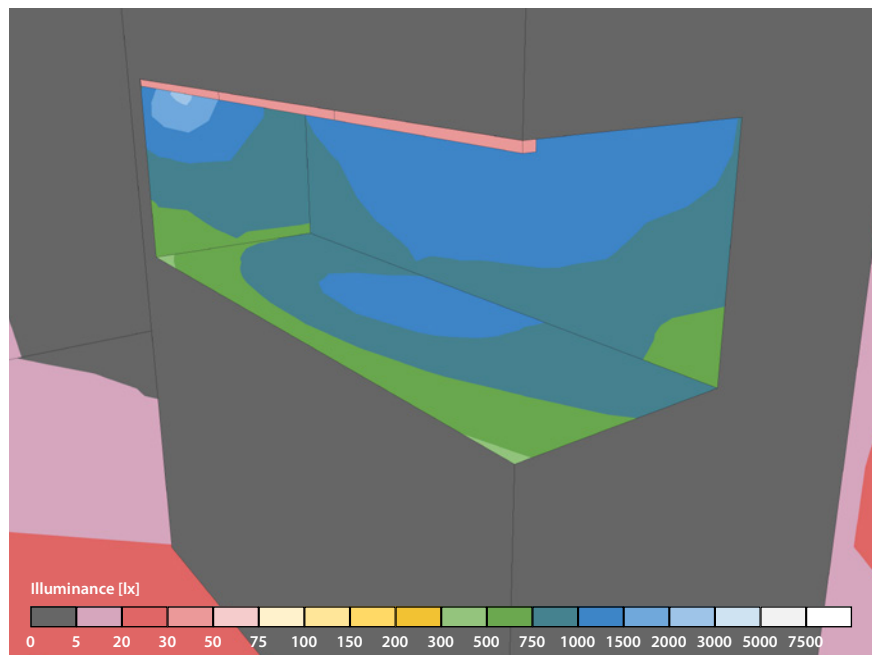

Linear

TANA Asymmetric AS30 (30W) Code Table



FIXTURE

Model	Finish	Cover/Lens	Grade ¹	LED	Colour (CCT)	Length Availability ²	IP	Cable Length	Power Feed ³	Input				
TANA Asymmetric	TAY	Silver Anodised	SA	KKLN-A2 Asymmetric lens	A2	A-	A	AS30	2700K 27 3000K 30 3500K 35 4000K 40	m 90-1013mm 38.46mm increments i 3.54-39.88in 1.51in increments (Specify length code OR total run length)	IP40 40	300mm (11.81in) 0300	Single no sheath tail S00X Double no sheath tail D00X Single no sheath IP20 connector S20X Double no sheath IP20 connector D20X	DC 24V g

¹ Refer to LED Grading Key on Specification sheet page

² Refer to Length Availability List or enter total run length instead of length code

³ Refer to Power Feed Options on Options pages

Code Example:

TAY	-	SA	-	A2	-	A-	-	AS30	-	30	-	m	513	-	40	-	0300	-	D20X	-	g
TANA Asymmetric		Silver Anodised		KKLN-A2 Asymmetric lens		A-		AS30		3000K		513mm		IP40		300mm (11.81in)		Double no sheath IP20 connector		DC 24V	

LED ENGINE VARIANTS (LED STRIP TYPE)

Colour	LED	Lumen/m	Lumen/ft	W/m	W/ft	Spec Doc	Length	Increment
Single CCT	R020	1640	500	20	6.10	TANA Asymmetric R020	96-1013mm (3.78-39.88in)	41.7mm (1.64in)
	AS30	2970	905	30	9.14	TANA Asymmetric AS30	90-1013mm (3.54-39.88in)	38.46mm (1.51in)

* Performance data: A/s-line, Asymmetric lens, 3000K

TANA Asymmetric AS30 (30W)

Length Availability List



Length Code		Fixture Length ¹		LED Strip ²		End Cap Dimension		Wattage (W)	Output (lm)
Metric	Imperial(US)	Metric	Imperial(US)	Metric	Imperial(US)	Metric	Imperial(US)		
m0090	i0004	90mm	3.54in	77mm	3.03in	3mm	0.12in	2.31	228
m0128	i0005	128mm	5.05in	115mm	4.54in	3mm	0.12in	3.46	343
m0167	i0007	167mm	6.57in	154mm	6.06in	3mm	0.12in	4.62	457
m0205	i0008	205mm	8.08in	192mm	7.57in	3mm	0.12in	5.77	571
m0244	i0010	244mm	9.60in	231mm	9.09in	3mm	0.12in	6.92	685
m0282	i0011	282mm	11.11in	269mm	10.60in	3mm	0.12in	8.08	800
m0321	i0013	321mm	12.63in	308mm	12.11in	3mm	0.12in	9.23	914
m0359	i0014	359mm	14.14in	346mm	13.63in	3mm	0.12in	10.38	1028
m0398	i0016	398mm	15.65in	385mm	15.14in	3mm	0.12in	11.54	1142
m0436	i0017	436mm	17.17in	423mm	16.66in	3mm	0.12in	12.69	1257
m0475	i0019	475mm	18.68in	462mm	18.17in	3mm	0.12in	13.85	1371
m0513	i0020	513mm	20.20in	500mm	19.69in	3mm	0.12in	15.00	1485
m0551	i0022	551mm	21.71in	538mm	21.20in	3mm	0.12in	16.15	1599
m0590	i0023	590mm	23.23in	577mm	22.71in	3mm	0.12in	17.31	1713
m0628	i0025	628mm	24.74in	615mm	24.23in	3mm	0.12in	18.46	1828
m0667	i0026	667mm	26.25in	654mm	25.74in	3mm	0.12in	19.62	1942
m0705	i0028	705mm	27.77in	692mm	27.26in	3mm	0.12in	20.77	2056
m0744	i0029	744mm	29.28in	731mm	28.77in	3mm	0.12in	21.92	2170
m0782	i0031	782mm	30.80in	769mm	30.28in	3mm	0.12in	23.08	2285
m0821	i0032	821mm	32.31in	808mm	31.80in	3mm	0.12in	24.23	2399
m0859	i0034	859mm	33.82in	846mm	33.31in	3mm	0.12in	25.38	2513
m0898	i0035	898mm	35.34in	885mm	34.83in	3mm	0.12in	26.54	2627
m0936	i0037	936mm	36.85in	923mm	36.34in	3mm	0.12in	27.69	2742
m0975	i0038	975mm	38.37in	962mm	37.86in	3mm	0.12in	28.85	2856
m1013	i0040	1013mm	39.88in	1000mm	39.37in	3mm	0.12in	30.00	2970

¹ Actual total overall length of light fixture (LED strip + end caps + void/wire hole)

² Actual length of PCB strip

³ Actual length of 2x end caps

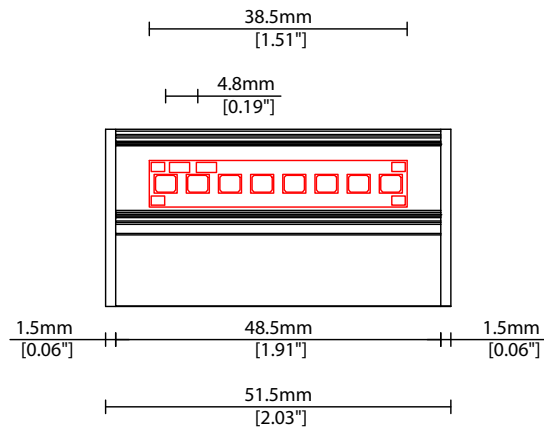

Linear

TANA Asymmetric AS30 (30W) Options

KKDC

COVER/LENS OPTIONS

* Options are an integral part of the fixture ordering codes. Please refer to **Code Table** pages.

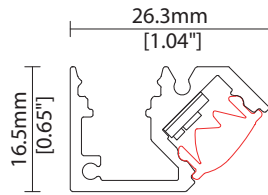

A2 KKLN-A2 Asymmetric lens
W26.3/H16.5mm (W1.04/H0.65")

Key

Control Gear Power supply, sub-controllers & control systems
JB Junction box / cable connection

POWER FEED OPTIONS

* Options are an integral part of the fixture ordering codes. Please refer to **Code Table** pages.

0300 S00X 300mm (11.81") Single no sheath tail

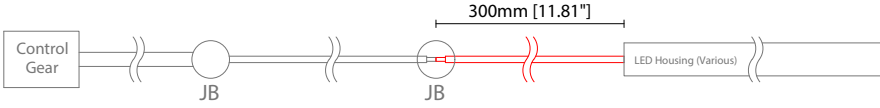

0300 D00X 300mm (11.81") Double no sheath tail

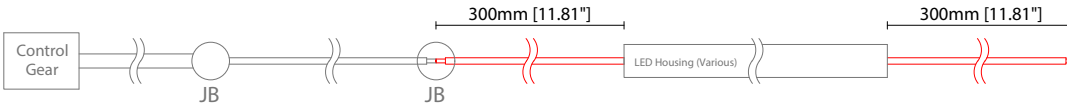

0300 S20X 300mm (11.81") Single no sheath IP20 connector

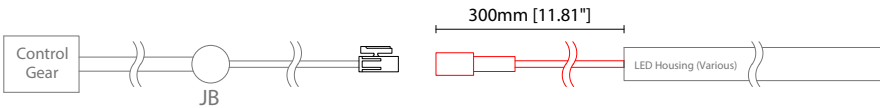

0300 D20X 300mm (11.81") Double no sheath IP20 connector

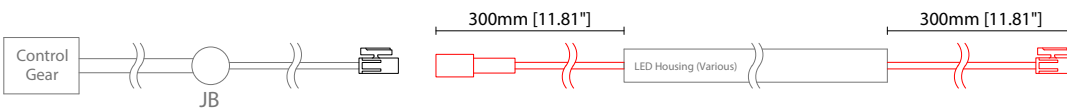

2 Pin Female Connector

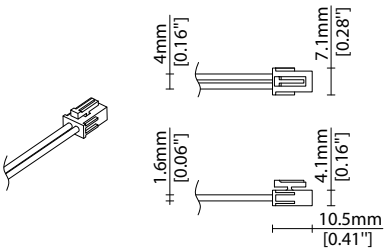

2 Pin Male Connector

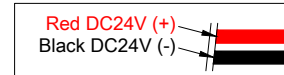
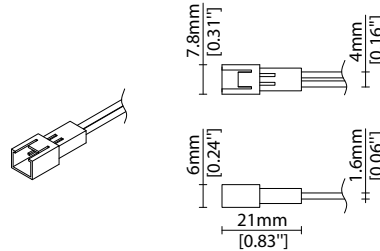

Key

- Control Gear Power supply, sub-controllers & control systems
- JB Junction box / cable connection

Linear

TANA Asymmetric AS30 (30W) Accessories

KKDC

MOUNTING ACCESSORIES

Note: Accessories are to be ordered separately with corresponding code shown below.



KKCP-10

Concealed clip
(Allow 2 per metre/40in)
S/Steel finish
L20/W16/H16mm
(L0.79/W0.63/H0.63")

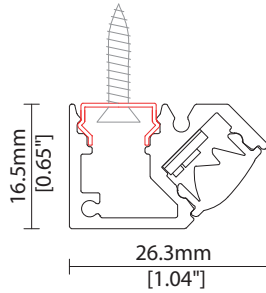

KKDC CONTROL



IP20
Plastic housing
L170/W59/H29mm
(L6.69/W2.32/H1.14in)

KKDM-06 1-10V

visDIM dimmable sub-controller
(4 x 8A max @ 12-36V)



IP20
Plastic housing
L170/W53.4/H28mm
(L6.69/W2.10/H1.10in)

KKSC-05 DMX

visDIM dimmable sub-controller
(4 x 5A max @ 12-36V)



IP20
Plastic housing
L170/W59/H29mm
(L6.69/W2.32/H1.14in)

KKDL-02 DALI

visDIM dimmable sub-controller
(4 x 8A max @ 12-36V)



IP20
Plastic housing
L166/W53.4/H23mm
(L6.54/W2.10/H0.91in)

KKDL-03 DALI

visDIM dimmable sub-controller
(4 x 5A max @ 12-36V)



IP20
Plastic housing
L170/W53.4/H28mm
(L6.69/W2.10/H1.10in)

KKDL-04 DALI-2

visDIM dimmable sub-controller
(4 x 5A max @ 12-36V)



IP20
Plastic housing
L170/W53.4/H28mm
(L6.69/W2.10/H1.10in)

visDIM PRO 30 DALI-2

30kHz PWM Frequency
visDIM dimmable sub-controller
(4 x 5A max @ 12-36V)

AVAILABLE PSU OPTIONS

Control Mode	PSU (Order Code)	Input Voltage AC	Output Voltage DC	Rated Output Current	Rated Power	Dim %	IP Rating
Switched	CEN-60-24	90-295V	24V	2.5A	60W	-	IP67
	HLG-60H-24	90-305V	24V	2.5A	60W	-	IP67
	HLG-100H-24	90-305V	24V	4.0A	100W	-	IP67
	HLG-150H-24	90-305V	24V	6.3A	150W	-	IP67
	HLG-240H-24	90-305V	24V	10A	240W	-	IP67
0-10V (1-10V)	PWM-40-24	90-305V	24V	1.67A	40W	100-0.15 (100-10)	IP67
	PWM-60-24	90-305V	24V	2.5A	60W	100-0.15 (100-10)	IP67
	PWM-90-24	90-305V	24V	3.67A	90W	100-0.15 (100-10)	IP67
	PWM-120-24	90-305V	24V	5.0A	120W	100-0.15 (100-10)	IP67
DALI	LIN100A1	120-277V	24V	1A per channel	100W	100-0.1	IP66/IP40
DMX RGB	LIN100A1	120-277V	24V	1.33A per channel	100W	100-0.1	IP66/IP40
DMX RGBW	LIN100A1	120-277A	24V	1A per channel	100W	100-0.1	IP66/IP40

Flicker Free Options - Combination of PSU+ sub-controller

Control Mode	PSU (Order Code)	Sub-controller (Order Code)	Input Voltage AC	Output Voltage DC	Rated Output Current	Rated Power	Dim %	IP Rating PSU/ Sub-controller
0-10V or 1-10V	CEN-60-24	KKDM-06	90-295V	24V	2.5A	60W	100-0.9	IP67/IP20
	HLG-60H-24	KKDM-06	90-295V	24V	2.5A	60W	100-0.9	IP67/IP20
	HLG-100H-24	KKDM-06	90-295V	24V	4.0A	100W	100-0.9	IP67/IP20
	HLG-150H-24	KKDM-06	90-295V	24V	6.3A	150W	100-0.9	IP67/IP20
	HLG-240H-24	KKDM-06	90-295V	24V	10.0A	240W	100-0.9	IP67/IP20
DALI	CEN-60-24	KKDL-02/03/04/visDIM PRO 30	90-295V	24V	2.5A	60W	100-0.1	IP67/IP20
	HLG-60H-24	KKDL-02/03/04/visDIM PRO 30	90-305V	24V	2.5A	60W	100-0.1	IP67/IP20
	HLG-100H-24	KKDL-02/03/04/visDIM PRO 30	90-305V	24V	4.0A	100W	100-0.1	IP67/IP20
	HLG-150H-24	KKDL-02/03/04/visDIM PRO 30	90-305V	24V	6.3A	150W	100-0.1	IP67/IP20
	HLG-240H-24	KKDL-02/03/04/visDIM PRO 30	90-305V	24V	10.0A	240W	100-0.1	IP67/IP20
DMX RGB	CEN-60-24	KKSC-05	90-295V	24V	2.5A	60W	100-0.9	IP67/IP20
	HLG-60H-24	KKSC-05	90-305V	24V	2.5A	60W	100-0.9	IP67/IP20
	HLG-100H-24	KKSC-05	90-305V	24V	4A	100W	100-0.9	IP67/IP20
	HLG-150H-24	KKSC-05	90-305V	24V	6.3A	150W	100-0.9	IP67/IP20
	HLG-240H-24	KKSC-05	90-305V	24V	10.0A	240W	100-0.9	IP67/IP20

¹ The items shown above cover the most frequently used specification but does not exhaust the possible options

² PSU and/or driver can be chosen from the table, or KKDC may recommend the best option upon receipt of the controls requirement and installation environment

³ Electrical shop drawing will include detailed information of PSU and relevant control drivers

⁴ Cut sheets are available on the controls section of www.kkdc.lighting or upon request